

Article number: 390204901073236

Description: Worm Gear with Torque Limiter
VF 49-L2-P-10 P80B5

Measures

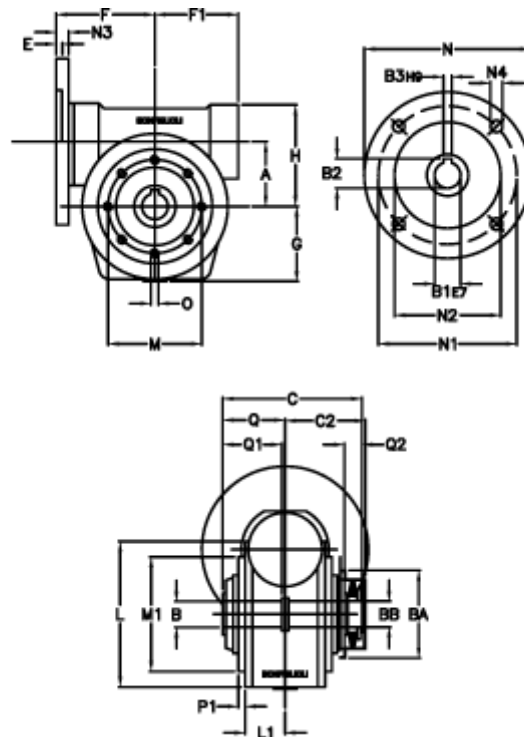

a = 49.50	C2 = 63,5	L1 = 36.8	O = M6x8
B = 25	Description = VF 49P-xx-80B14	m = 94	P1 = 2.5
B1 E7 = 19	E = 3.0	M1 = 68	Q = 51.0
B2 = 21.8	F = 70	N = 120	Q1 = 41
B3 H9 = 6	F1 = 63	N1 = 100	Q2 = 15
BA = 63	g = 56	N2 = 80	
BB H7 = 14	H = 80.0	N3 = 10.0	
C = 105	L = 107.5	N4 = 7	